

DECLARATION OF PERFORMANCE

according to the Construction Products Regulation (EU) No.305/2011

Nr.: LE_08_0183_EN

- | | | |
|-----|--|--|
| 1. | Product type identification code | angle connector
Dimensions: see ETA -08/0183 |
| 2. | Type, batch, series numbers or other identification code | ETA-08/0183
Batch number: see label |
| 3. | Intended use | Fasteners for supporting wooden structures, as well as for the fastening of beams and purlins in accordance with ETA-08/0183 |
| 4. | Manufacturer contact address | BB Stanz- und Umformtechnik GmbH
Nordhäuser Str. 44
06536 Berga
Germany |
| 5. | System or systems for durability assessment and testing | System 2+ |
| 6. | Reference document | ETA-08/0183 |
| 7. | Eota ref. / number | ETA-Danmark A/S, Charlottenlund |
| 8. | Conducted by the certification authority | - Initial inspection of the manufacturing plant and of factory production control
- Current monitoring, analysis and assessment of factory production control
- Result in conformity certificate 0769-CPD-6006 |
| 9. | Declared performance | See ETA-08/0183 |
| 10. | Product performance pursuant to item 1 and 2 corresponds to the declared performance pursuant to item 9. The manufacturer pursuant to item 4 is liable for this Performance Declaration. | |

Signed for the manufacturer and on behalf of the manufacturer by:

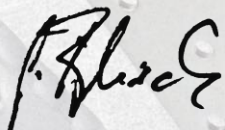

Günther Blesch
(Chief Operating Officer)
Berga, 13.01.2017

ETA-Danmark A/S
Kollegievej 6
DK-2920 Charlottenlund
Tel. +45 72 24 59 00
Fax +45 72 24 59 04
Internet www.etadanmark.dk



Authorised and notified according to Article 10 of the Council Directive 89/106/EEC of 21 December 1988 on the approximation of laws, regulations and administrative provisions of Member States relating to construction products

MEMBER OF EOTA

European Technical Approval ETA-08/0183

This ETA replaces the previous ETA with the same number and validity from 2008-07-03 to 2013-07-03

Trade name:

BB Angle Bracket 70 with and without rib
BB Angle Bracket 90 with and without rib
BB Angle Bracket 105 with and without rib

Holder of approval:

BB Stanz- und Umformtechnik
Nordhäuser Str. 42
D-06536 Berga
Tel. +49 34651 2988 0
Fax +49 34651 2988 20
Internet www.bb-berga.de

Generic type and use of construction product:

Three-dimensional nailing plate (angle bracket for wood to wood connections)

Valid from:
to:

2013-06-19
2018-06-19

Manufacturing plant:

BB Stanz- und Umformtechnik
Nordhäuser Str. 42
D-06536 Berga

This European Technical Approval contains:

26 pages including 3 annexes which form an integral part of the document



European Organisation for Technical Approvals

Europæisk Organisation for Tekniske Godkendelser

I LEGAL BASIS AND GENERAL CONDITIONS

1 This European Technical Approval is issued by ETA-Danmark A/S in accordance with:

- Council Directive 89/106/EEC of 21 December 1988 on the approximation of laws, regulations and administrative provisions of Member States relating to construction products¹⁾, as amended by Council Directive 93/68/EEC of 22 July 1993²⁾.

- Bekendtgørelse 559 af 27-06-1994 (afløser bekendtgørelse 480 af 25-06-1991) om ikrafttræden af EF direktiv af 21. december 1988 om indbyrdes tilnærmelse af medlemsstaternes love og administrative bestemmelser om byggevarer.

- Common Procedural Rules for Requesting, Preparing and the Granting of European Technical Approvals set out in the Annex to Commission Decision 94/23/EC³⁾.

- EOTA Guideline ETAG 015 *Three-dimensional nailing plates*, September 2002 edition.

2 ETA-Danmark A/S is authorized to check whether the provisions of this European Technical Approval are met. Checking may take place in the manufacturing plant. Nevertheless, the responsibility for the conformity of the products to the European Technical Approval and for their fitness for the intended use remains with the holder of the European Technical Approval.

3 This European Technical Approval is not to be transferred to manufacturers or agents of manufacturers other than those indicated on page 1, or manufacturing plants other than those indicated on page 1 of this European Technical Approval.

4 This European Technical Approval may be withdrawn by ETA-Danmark A/S pursuant to Article 5(1) of Council Directive 89/106/EEC.

1) Official Journal of the European Communities N° L40, 11 Feb 1989, p 12.

2) Official Journal of the European Communities N° L220, 30 Aug 1993, p 1.

3) Official Journal of the European Communities N° L 17, 20 Jan 1994, p 34.

5 Reproduction of this European Technical Approval including transmission by electronic means shall be in full. However, partial reproduction can be made with the written consent of ETA-Danmark A/S. In this case partial reproduction has to be designated as such. Texts and drawings of advertising brochures shall not contradict or misuse the European Technical Approval.

6 This European Technical Approval is issued by ETA-Danmark A/S in English. This version corresponds fully to the version circulated within EOTA. Translations into other languages have to be designated as such.

I SPECIAL CONDITIONS OF THE EUROPEAN TECHNICAL APPROVAL

1 Definition of product and intended use

Definition of the product

BB Angle Bracket Type A70, 90 and 105 with and without rib are one-piece non-welded, face-fixed angle brackets to be used in timber to timber connections. They are connected to the timber elements by a range of profiled nails.

The angle brackets are made from pre-galvanized steel S 250 GD + Z 275 according to EN 10346:2009 and are available with or without an embossed rib. Dimensions, hole positions and typical installations are shown in Annex A. BB angle brackets are made from steel with tolerances according to EN 10143.

Intended use

The angle brackets are intended for use in making connections in load bearing timber structures, as a connection between a beam and a purlin, where requirements for mechanical resistance and stability and safety in use in the sense of the Essential Requirements 1 and 4 of Council Directive 89/106/EEC shall be fulfilled.

The connection may be with a single angle bracket or with an angle bracket on each side of the fastened timber member (see Annex A).

The static and kinematic behaviour of the timber members or the supports shall be as described in Annex B.

The wood members can be of solid timber, glued laminated timber and similar glued members, or wood-based structural members with a characteristic density from 290 kg/m³ to 420 kg/m³. This requirement to the material of the wood members can be fulfilled by using the following materials:

- Structural solid timber classified to C14-C40 according to EN 338 / EN 14081,
- Glulam classified to GL24-GL36 according to EN 1194 / EN 14080,
- LVL according to EN 14374,
- Parallam PSL,
- Intrallam LSL,
- Duo- and Triobalken,
- Layered wood plates,
- Plywood according to EN 636

Annex B states the load-carrying capacities of the angle bracket connections for a characteristic density of 350 kg/m³. For timber or wood based material with a lower characteristic density than 350 kg/m³ the load-carrying capacities for angle brackets from steel with thickness 2,5 mm shall be reduced

by the k_{dens} factor:

$$k_{\text{dens}} = \left(\frac{\rho_k}{350} \right)^2$$

For angle brackets from steel with thickness 1,5 mm the load-carrying capacities shall be reduced by the k_{dens} factor:

$$k_{\text{dens}} = \left(\frac{\rho_k}{350} \right)^{0,8}$$

Where ρ_k is the characteristic density of the timber in kg/m³.

The design of the connections shall be in accordance with Eurocode 5 or a similar national Timber Code. The wood members shall have a thickness which is larger than the penetration depth of the nails into the members.

The angle brackets are primarily for use in timber structures subject to the dry, internal conditions defined by service class 1 and 2 of Eurocode 5 and for connections subject to static or quasi-static loading.

The angle brackets may also be used for connections between a timber member and a member of concrete or steel.

Assumed working life

The assumed intended working life of the angle brackets for the intended use is 50 years, provided that they are subject to appropriate use and maintenance.

The information on the working life should not be regarded as a guarantee provided by the manufacturer or ETA Danmark. An "assumed intended working life" means that it is expected that, when this working life has elapsed, the real working life may be, in normal use conditions, considerably longer without major degradation affecting the essential requirements.

2 Characteristics of product and assessment

ETAG paragraph	Characteristic	Assessment of characteristic
	2.1 Mechanical resistance and stability*)	
6.1.1	Characteristic load-carrying capacity	See Annex B
6.1.2	Stiffness	No performance determined
6.1.3	Ductility in cyclic testing	No performance determined
	2.2 Safety in case of fire	
6.2.1	Reaction to fire	The angle brackets are made from steel classified as Euroclass A1 in accordance with EN 1350-1 and EC decision 96/603/EC, amended by EC Decision 2000/605/EC
	2.3 Hygiene, health and the environment	
6.3.1	Influence on air quality	No dangerous materials **)
	2.4 Safety in use	Not relevant
	2.5 Protection against noise	Not relevant
	2.6 Energy economy and heat retention	Not relevant
	2.7 Related aspects of serviceability	
6.7.1	Durability	The angle brackets have been assessed as having satisfactory durability and serviceability when used in timber structures using the timber species described in Eurocode 5 and subject to the conditions defined by service class 1 and 2
6.7.2	Serviceability	
6.7.3	Identification	

*) See page 5 of this ETA

**) In accordance with <http://europa.eu.int/comm/enterprise/construction/internal/dangsub/dangmain.htm> In addition to the specific clauses relating to dangerous substances contained in this European Technical Approval, there may be other requirements applicable to the products falling within its scope (e.g. transposed European legislation and national laws, regulations and administrative provisions). In order to meet the provisions of the EU Construction Products Directive, these requirements need also to be complied with, when and where they apply.

Safety principles and partial factors

The characteristic load-carrying capacities for angle brackets from steel with thickness 2,5 mm are based on the characteristic values of the nail connections and the steel plates. To obtain design values the capacities have to be multiplied with different partial factors for the material properties, in addition the nail connection with the coefficient k_{mod} .

According to EN 1990 (Eurocode – Basis of design) paragraph 6.3.5 the design value of load-carrying capacity can be determined by reducing the characteristic values of the load-carrying capacity with different partial factors.

Thus, the characteristic values of the load-carrying capacity are determined also for timber failure $F_{Rk,H}$ (obtaining the embedment strength of nails subjected to shear or the withdrawal capacity of the most loaded nail, respectively) as well as for steel plate failure $F_{Rk,S}$. The design value of the load-carrying capacity is the smaller value of both load-carrying capacities.

$$F_{Rd} = \min \left\{ \frac{k_{mod} \cdot F_{Rk,H}}{\gamma_{M,H}}; \frac{F_{Rk,S}}{\gamma_{M,S}} \right\}$$

Therefore, for timber failure the load duration class and the service class are included. The different partial factors γ_M for steel or timber, respectively, are also correctly taken into account.

The characteristic load-carrying capacities for angle brackets from steel with thickness 1,5 mm are based on testing.

As steel and timber failure are both decisive, the design value shall be calculated according to EN 1995-1-1 by reducing the characteristic values of the load-carrying capacity with the partial factor for timber or wood-based materials.

The design value of the load-carrying capacity is:

$$F_{Rd} = \frac{k_{mod} \cdot F_{Rk}}{\gamma_M}$$

2.1 Mechanical resistance and stability

See annex B for the characteristic load-carrying capacity in the different directions F_1 to F_5 .

The characteristic capacities of the angle brackets are determined by calculation assisted by testing as described in the EOTA Guideline 015 clause 5.1.2. They should be used for designs in accordance with Eurocode 5 or a similar national Timber Code.

The angle brackets in part were calculated for the different load cases with different nail patterns. (see Annex A). For combined loading the following nail patterns shall be used:

Angle Bracket 70 without rib:
 F_1 with F_2/F_3 or F_2/F_3 with F_4/F_5 : Nail Patterns F_2/F_3

Angle Bracket 90 with rib:
 F_1 with F_2/F_3 or F_2/F_3 with F_4/F_5 : Nail Patterns F_1

Angle Bracket 105 with rib:
 F_1 with F_2/F_3 or F_2/F_3 with F_4/F_5 : Nail Patterns F_1

Angle Bracket 105 without rib:
 F_1 with F_2/F_3 : Nail Patterns F_2/F_3

Angle Bracket 105 without rib:
 F_1 with F_4/F_5 : Nail Patterns F_4/F_5

Threaded nails (ringed shank nails) in accordance to EN 14592

In the formulas in Annex B the capacities for threaded nails calculated from the formulas of Eurocode 5 are used assuming a thick steel plate when calculating the lateral nail load-carrying-capacity.

The load bearing capacities of the brackets has been determined based on the use of connector nails 4,0 x 40 mm in accordance with the German national approval for the nails.

The characteristic withdrawal capacity of the nails has to be determined by calculation in accordance with EN 1995-1-1: 2004, paragraph 8.3.2 (head pull-through is not relevant):

$$F_{ax,Rk} = f_{ax,k} \times d \times t_{pen}$$

Where:

$f_{ax,k}$ Characteristic value of the withdrawal parameter in N/mm^2
 d Nail diameter in mm
 t_{pen} Penetration depth of the profiles shank in mm
 $t_{pen} \geq 30$ mm

Based on tests by Versuchsanstalt für Stahl, Holz und Steine, University of Karlsruhe, the characteristic value of the withdrawal resistance for the threaded nails used can be calculated as:

$$f_{ax,k} = 50 \times 10^{-6} \times \sigma_k^2$$

Where:

σ_k Characteristic density of the timber in kg/m^3

The shape of the nail directly under the head shall be in the form of a truncated cone with a diameter under the nail head which exceeds the hole diameter.

4,0 mm threaded nails with a truncated cone below the head are used as fasteners, which are particularly suitable for nailed steel-to-timber connections. The specific shape below the head causes a clamping of nails in the steel plate.

It is assumed that angle brackets 70 with and without rib are fastened with nails 4,0x40 with a profiled length including the nail point of at least 30 mm and angle brackets 90 and 105 with and without rib are fastened with nails 4,0x60 with a profiled length including the nail point of at least 50 mm.

The design models allow the use of fasteners described in table on page 11 in Annex A

No performance has been determined in relation to ductility of a joint under cyclic testing. The contribution to the performance of structures in seismic zones, therefore, has not been assessed.

No performance has been determined in relation to the joint's stiffness properties - to be used for the analysis of the serviceability limit state.

2.7 Related aspects of serviceability

2.7.1 Corrosion protection in service class 1 and 2.

In accordance with ETAG 015 the angle brackets are made from pre-galvanized steel S 250 GD + Z 275 according to EN 10327:2004

3 Attestation of Conformity and CE marking

3.1 Attestation of Conformity system

The system of attestation of conformity is 2+ described in Council Directive 89/106/EEC (Construction Products Directive) Annex III.

- a) Tasks for the manufacturer:
- (1) Factory production control,
 - (2) Initial type testing of the product,
- b) Tasks for the notified body:
- (1) Initial inspection of the factory and the factory production control,
 - (2) Continuous surveillance

3.2 Responsibilities

3.2.1 Tasks of the manufacturer

3.2.1.1 Factory production control

The manufacturer has a factory production control system in the plant and exercises permanent internal control of production. All the elements, requirements and provisions adopted by the manufacturer are documented in a systematic manner in the form of written policies and procedures. This production control system ensures that the product is in conformity with the European Technical Approval.

The manufacturer shall only use raw materials supplied with the relevant inspection documents as laid down in the control plan⁴. The incoming raw materials shall be subject to controls and tests by the manufacturer before acceptance. Check of materials, such as sheet metal, shall include control of the inspection documents presented by suppliers (comparison with nominal values) by verifying dimension and determining material properties, e.g. chemical composition, mechanical properties and zinc coating thickness.

The manufactured components are checked visually and for dimensions.

The control plan, which is part of the technical documentation of this European Technical Approval,

⁴ The control plan has been deposited at ETA-Danmark and is only made available to the approved bodies involved in the conformity attestation procedure.

includes details of the extent, nature and frequency of testing and controls to be performed within the factory production control and has been agreed between the approval holder and ETA Danmark.

The results of factory production control are recorded and evaluated. The records include at least the following information:

- Designation of the product, basic material and components;
- Type of control or testing;
- Date of manufacture of the product and date of testing of the product or basic material and components;
- Result of control and testing and, if appropriate, comparison with requirements;
- Signature of person responsible for factory production control.

The records shall be presented to ETA Danmark on request.

3.2.1.1 Initial type testing of the product

For initial type-testing the results of the tests performed as part of the assessment for the European Technical Approval shall be used unless there are changes in the production line or plant. In such cases the necessary initial type testing has to be agreed between ETA Danmark and the notified body.

3.2.2. Tasks of notified bodies

3.2.2.1 Initial inspection of the factory and the factory production control

The approved body should ascertain that, in accordance with the control plan, the factory, in particular the staff and equipment, and the factory production control, are suitable to ensure a continuous and orderly manufacturing of the angle brackets with the specifications given in part 2.

3.2.2.2 Continuous surveillance

The approved body shall visit the factory at least twice a year for routine inspections. It shall be verified that the system of factory production control and the specified manufacturing processes are maintained, taking account of the control plan.

The results of product certification and continuous surveillance shall be made available on demand by the certification body to ETA Danmark. Where the provisions of the European Technical Approval and the control plan are no longer fulfilled, the certificate

of conformity shall be withdrawn by the approved body.

3.3 CE marking

The CE marking shall be affixed on each packaging of angle brackets. The initials "CE" shall be followed by the identification number of the notified body and shall be accompanied by the following information:

- Name or identifying mark of the manufacturer
- The last two digits of the year in which the marking was affixed
- Number of the European Technical Approval
- Name and size of product
- Number of the ETA Guideline (ETAG no. 015)
- Number of the EC Certificate of Conformity

4 Assumptions under which the fitness of the product for the intended use was favourably assessed

4.1 Manufacturing

BB angle brackets are manufactured in accordance with the provisions of this European Technical Approval using the manufacturing processes as identified in the inspection of the plant by the notified inspection body and laid down in the technical documentation.

4.2 Installation

The nailing pattern used shall be either the maximum or the minimum pattern as defined in Annex A.

The following provisions concerning installation apply:

The structural members – the components 1 and 2 shown in the figure on page 20 - to which the brackets are fixed shall be:

- Restrained against rotation. At a load F_4/F_5 , the component 2 is allowed to be restrained against rotation by the Angle brackets.
- Strength class C14 or better, see section 1 of this ETA
- Free from wane under the bracket.
- The actual end bearing capacity of the timber member to be used in conjunction with the bracket is checked by the designer of the structure to ensure it is not less than the bracket capacity and, if necessary, the bracket capacity reduced accordingly.
- The gap between the timber members does not exceed 3 mm.
- There are no specific requirements relating to preparation of the timber members.

The execution of the connection shall be in accordance with the approval holder's technical literature.

4.3 Maintenance and repair

Maintenance is not required during the assumed intended working life. Should repair prove necessary, it is normal to replace the angle bracket.



Thomas Bruun
Manager, ETA-Danmark

Annex A
Product details

Product details definitions

Table A.1 Materials specification

Bracket type	Thickness (mm)	Steel specification	Coating specification
70 with rib	2,5	S 250 GD + Z 275	Z 275
70 without rib	2,5	S 250 GD + Z 275	Z 275
90 with rib	2,5	S 250 GD + Z 275	Z 275
90 without rib	2,5	S 250 GD + Z 275	Z 275
105 with rib	3,0	S 250 GD + Z 275	Z 275
105 without rib	3,0	S 250 GD + Z 275	Z 275

Bracket type	Thickness (mm)	Steel specification	Coating specification
70 with rib	1,5	S 250 GD + Z 275	Z 275
90 with rib	1,5	S 250 GD + Z 275	Z 275
105 with rib	1,5	S 250 GD + Z 275	Z 275

Table A.2 Range of sizes, 2,5 mm thick

Bracket type	Height (mm)		Width (mm)	
	min	max	min	max
70 with rib	70	70	52	55
70 without rib	70	70	55	55
90 with rib	90	90	62	65
90 without rib	90	90	65	65
105 with rib	105	105	90	90
105 without rib	105	105	90	90

Table A.3 Range of sizes, 1,5 mm thick

Bracket type	Height (mm)		Width (mm)	
	min	max	min	max
70 with rib	69	71	52	55
90 with rib	89	91	62	65
105 with rib	104	106	87	90

Table A.3 Fastener specification

NAIL diameter	Length Min – max	Nail type
4.0	60 - 100	Ringed shank nails according to EN 14592
<p>The load-carrying capacities of the angle brackets were determined based on the use of connector nails 4,0 x 60 mm in accordance with the German national approval for the nails. The characteristic withdrawal capacity of the nails has to be determined by calculation in accordance with EN 1995-1-1: 2004, paragraph 8.3.2 (head pull-through is not relevant):</p> $F_{ax,Rk} = f_{1,k} \times d \times t_{pen}$ <p>Where:</p> <p>$f_{1,k}$ Characteristic value of the withdrawal parameter in N/mm² d Nail diameter in mm t_{pen} Penetration depth of the profiled shank in mm</p> <p>Based on tests by Versuchsanstalt für Stahl, Holz und Steine, University of Karlsruhe, the characteristic value of the withdrawal resistance for the threaded nails used can be calculated as:</p> $f_{1,k} = 50 \times 10^{-6} \times \rho_k^2$ <p>Where:</p> <p>ρ_k Characteristic density of the timber in kg/m³</p> <p>The shape of the nail directly under the head shall be in the form of a truncated cone with a diameter under the nail head which exceeds the hole diameter.</p>		

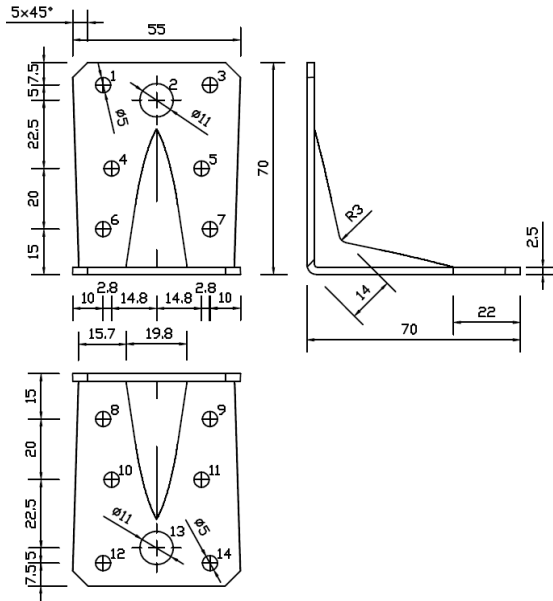

Figure A.1 Dimensions of Angle Bracket 70 with rib

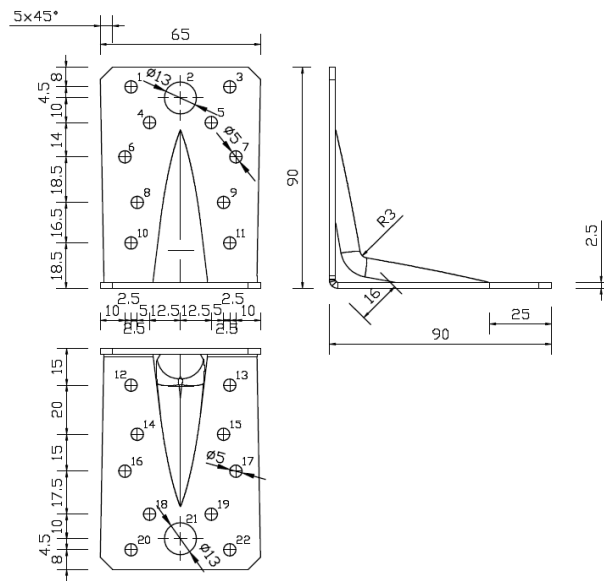
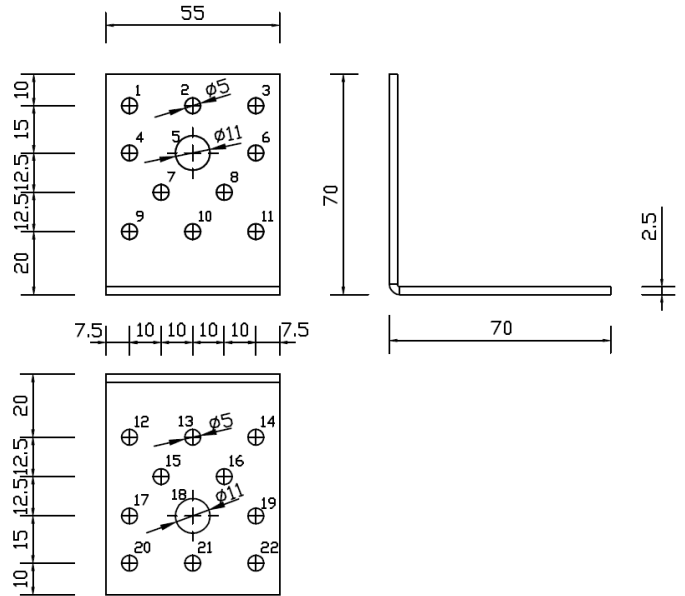

Figure A.3 Dimensions of Angle Bracket 90 with rib

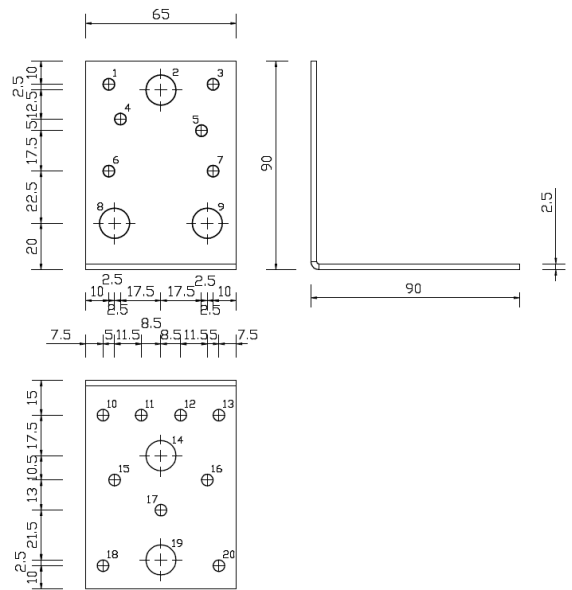

Figure A.4 Dimensions of Angle Bracket 90 without rib

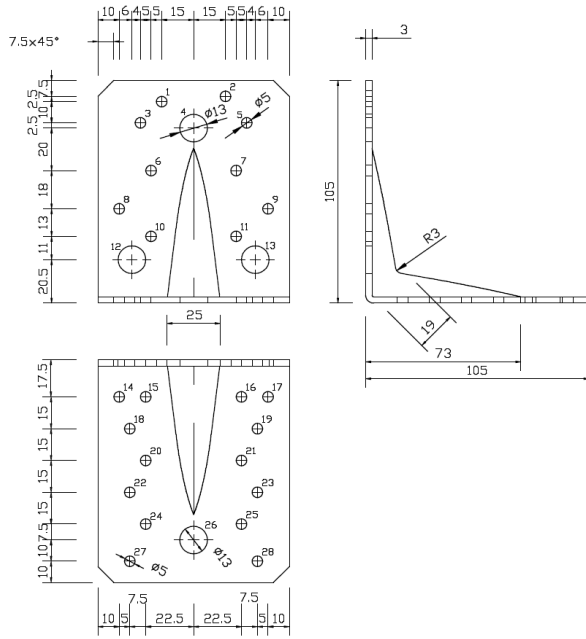

Figure A.5 Dimensions of Angle Bracket 105 with rib

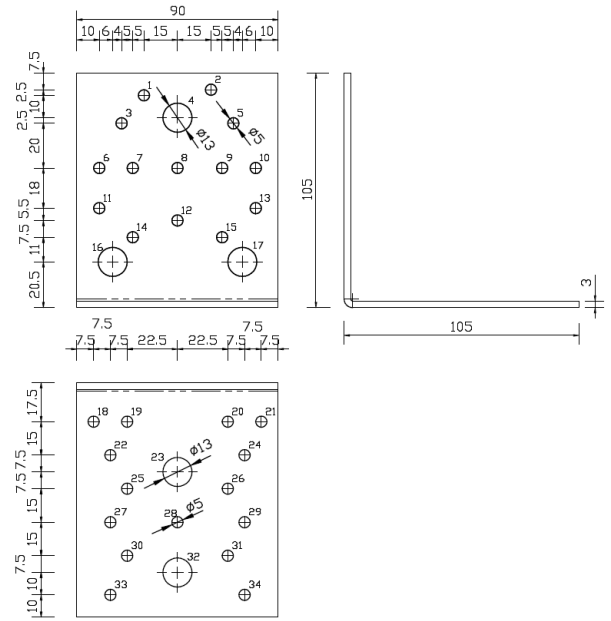

Figure A.6 Dimensions of Angle Bracket 105 without rib

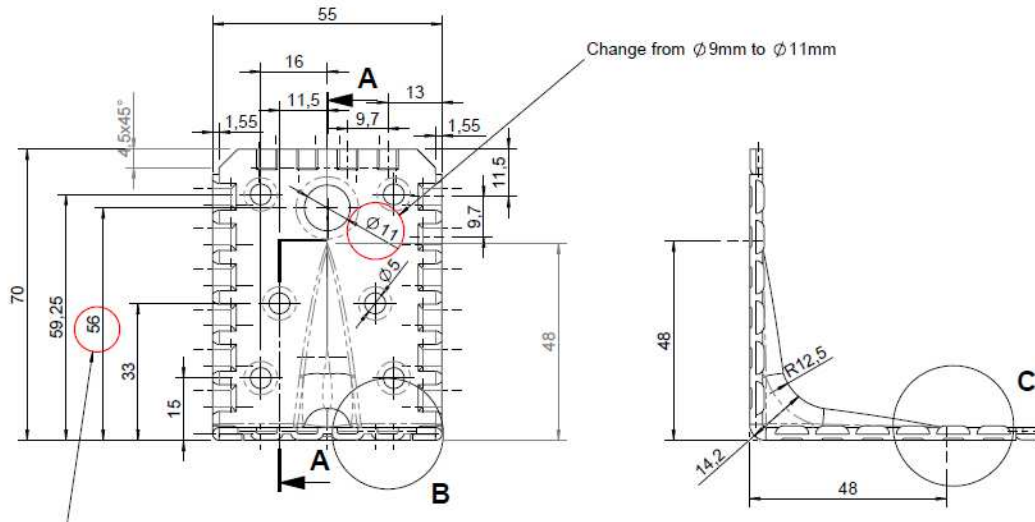

Figure A.7 Dimensions of Angle Bracket 70 with rib, thickness 1,5 mm

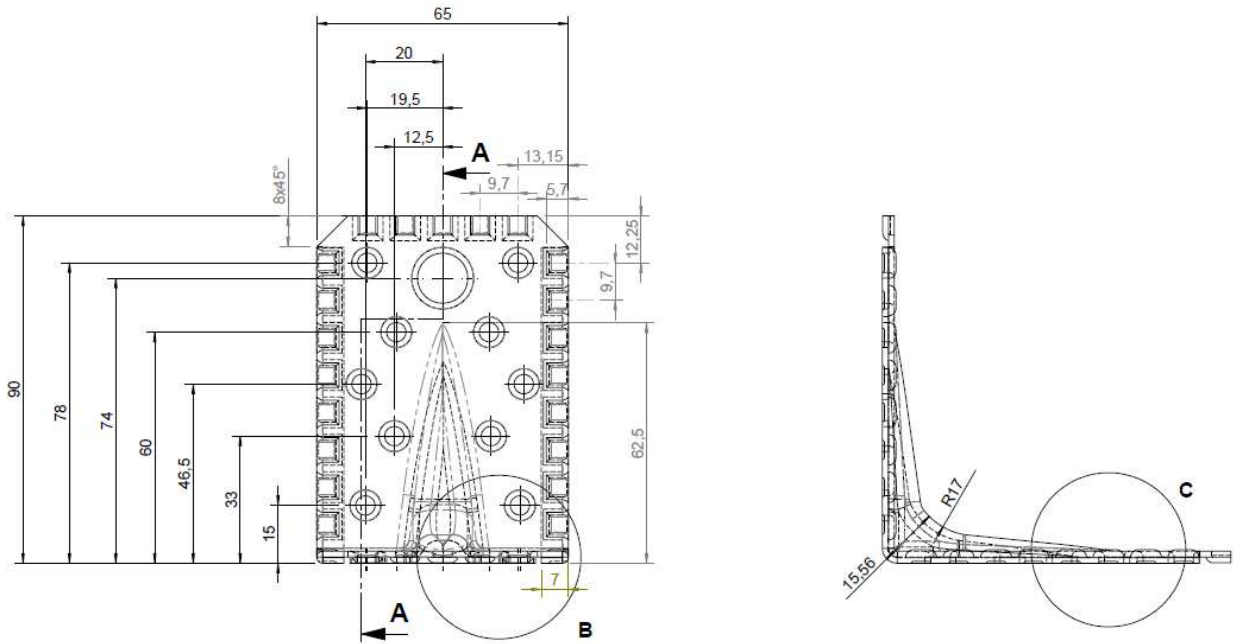
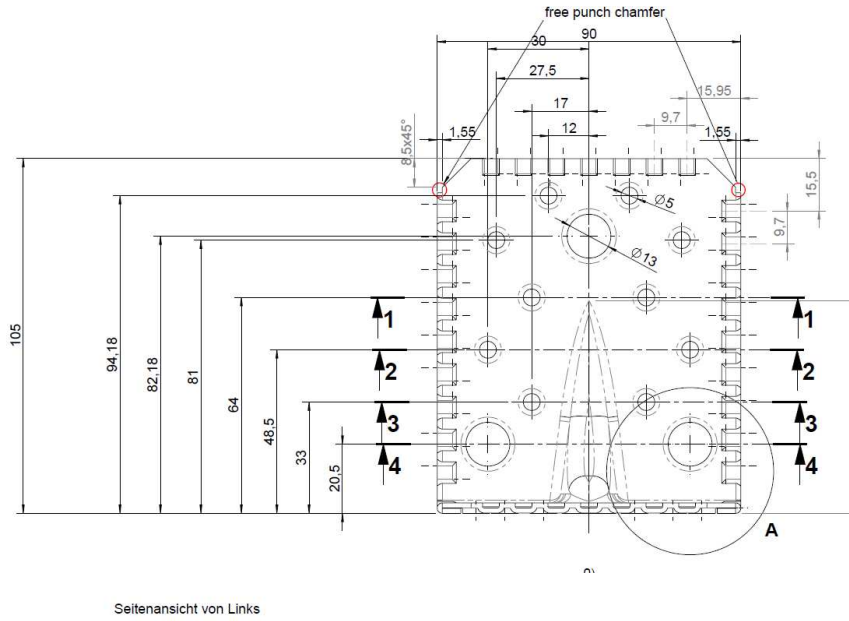

Figure A.8 Dimensions of Angle Bracket 90 with rib, thickness 1,5 mm



Seitenansicht von Links

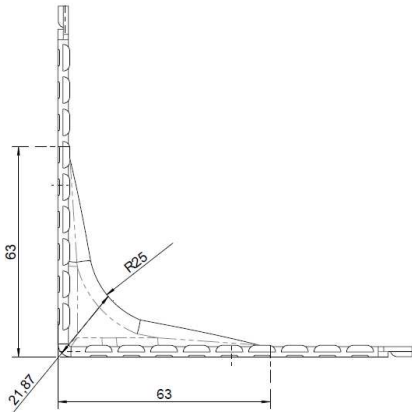

Figure A.9 Dimensions of Angle Bracket 105 with rib, thickness 1,5 mm

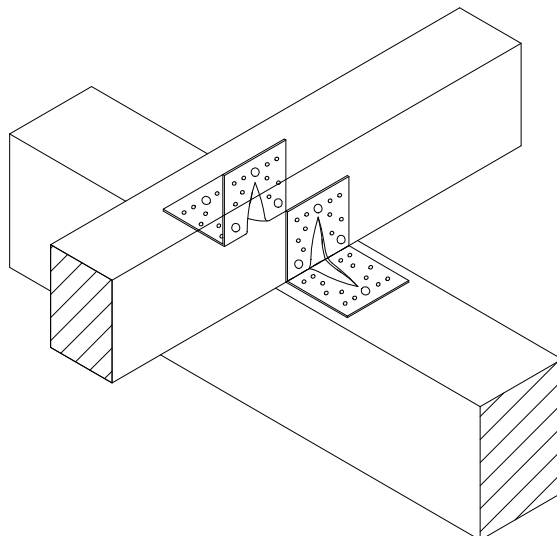
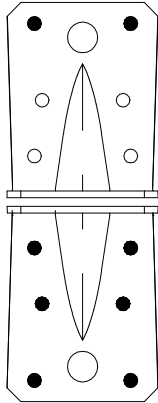

Figure A.10 Typical installation

Nail Patterns – Angle Bracket 70 with rib

LC 1 – column

Nails in hole number:
1,3 /
8,9,10,11,12,14



LC 1 – purlin

Nails in hole number:
1,3,4,5 /
8,9,10,11,12,14

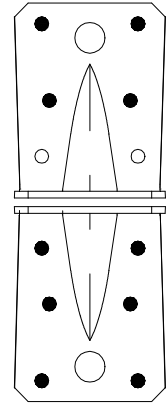

LC 2/3

Nails in hole number:
1,3,4,5 /
8,9,10,11,12,14

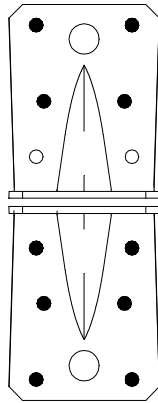

LC 4/5

Nails in hole number:
1,3,4,5 /
8,9,10,11,12,14

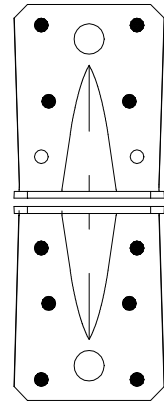

Nail Patterns – Angle Bracket 70 without rib

LC 1 – column

Nails in hole number:
1,2,3 /
12,13,14,20,21,22

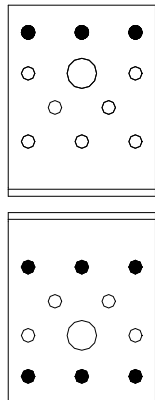

LC 1 – purlin

Nails in hole number:
1,2,3,4,6,7,8 /
12,13,14,20,21,22

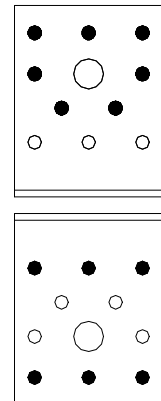

Nail Patterns – Angle Bracket 70 without rib

LC 2/3

Nails in hole number:
1,3,4,6,9,11 /
12,13,14,20,21,22

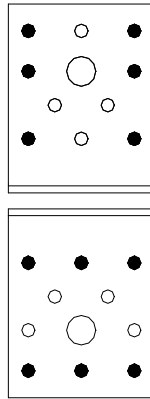

LC 4/5

Nails in hole number:
1,2,3,4,6,7,8 /
12,13,14,20,21,22

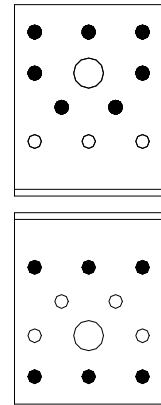

Nail Patterns – Angle Bracket 90 with rib

LC 1 – column

Nails in hole number:
1,3,6,7/
12,13,14,15,18,19

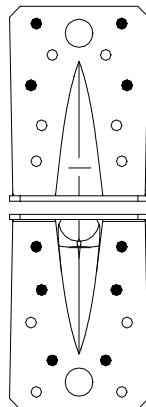

LC 1 – purlin

Nails in hole number:
1,3,4,5,6,7,8,9 /
12,13,14,15,18,19

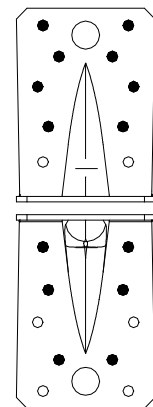

LC 2/3

Nails in hole number:
1,3,6,7,8,9 /
12,13,16,17,20,22

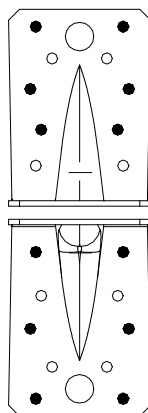

LC 4/5

Nails in hole number:
1,3,4,5,6,7,8,9 /
12,13,14,15,18,19

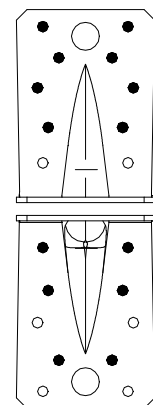

Nail Patterns – Angle Bracket 90 without rib

LC 1 – column

Nails in hole number:
1,3,5/
10,11,12,13,15,16
17,18,20

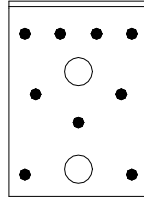
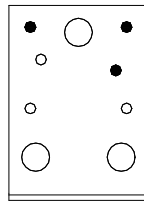

LC 1 – purlin

Nails in hole number:
1,3,4,5,6,7/
10,11,12,13,,15,16
17,18,20

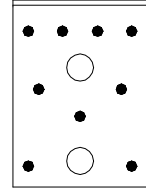
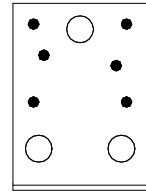

LC 2/3

Nails in hole number:
1,3,6,7,8,9 /
12,13,16,17,20,22

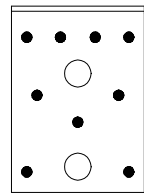
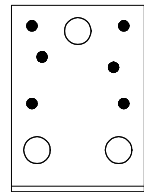

LC 4/5

Nails in hole number:
1,3,4,5,6,7,8,9 /
12,13,14,15,18,19

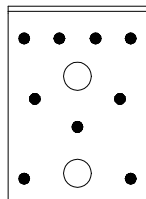
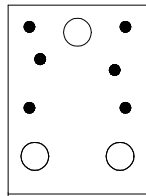

Nail Patterns – Angle Bracket 105 with rib

LC 1 – column

Nails in hole number:
1,2,6,7 /
14,15,16,17,20,21,24,25

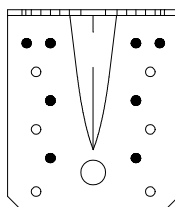
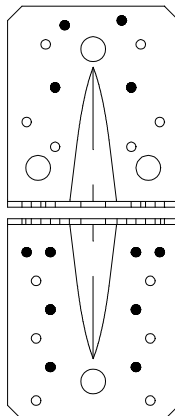

LC 1 – purlin

Nails in hole number:
1,2,3,5,6,7,8,9,10,11 /
14,15,16,17,20,21,24,25

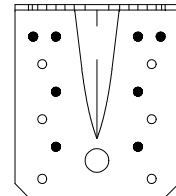
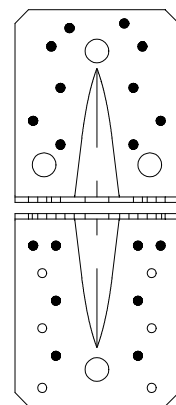

Nail Patterns – Angle Bracket 105 with rib

LC 2/3

Nails in hole number:
1,2,6,7,10,11 /
14,15,16,17,22,23,27,28

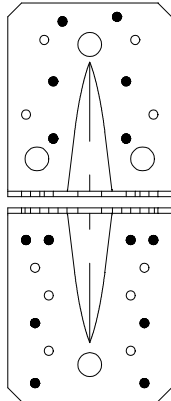

LC 4/5

Nails in hole number:
1,2,3,5,6,7,8,9,10,11 /
14,15,16,17,20,21,24,25

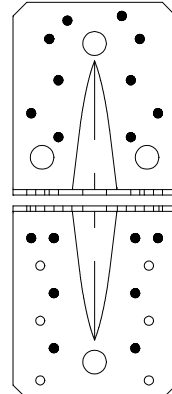

Nail Patterns – Angle Bracket 105 without rib

LC 1 – column

Nails in hole number:
1,2,6,7,8,9,10
18,19,20,21,25,26,30,31

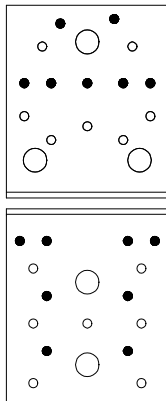

LC 1 – purlin

Nails in hole number:
1,2,3,5,6,8,10,12,14,15 /
18,19,20,21,25,26,30,31

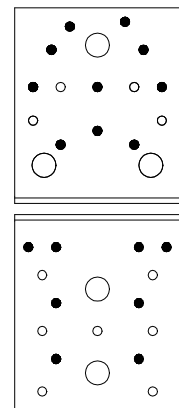

LC 2/3

Nails in hole number:
1,2,6,8,10,11,13,14,15 /
18,19,20,21,27,28,29,33,34

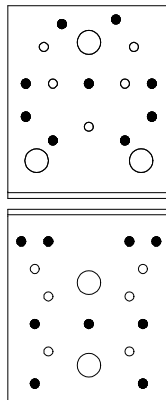

LC 4/5

Nails in hole number:
1,2,3,5,6,8,10,12,14,15 /
18,19,20,21,27,28,29,33,34

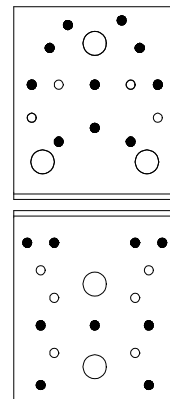

Annex B
Characteristic load-carrying capacities – brackets 2,5 mm thickness

Definitions of forces, their directions and eccentricity

Forces - Beam to beam connection

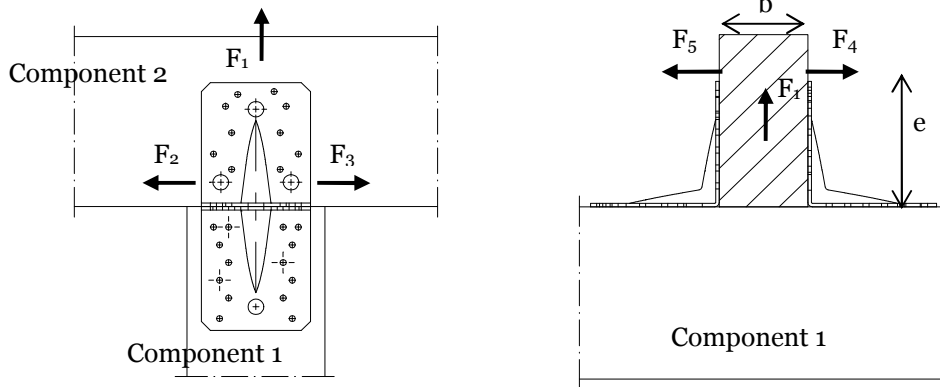

Fastener specification

Holes are marked with numbers referring to the nailing pattern in Annex A.

The holes which have to be nailed are given in Annex A for the different forces. If a connection is subjected to combined loading the following nail patterns have to be used:

Angle Bracket 70 without rib:	F_1 with F_2/F_3 or F_2/F_3 with F_4/F_5 :	Nail Patterns F_2/F_3
Angle Bracket 90 with rib:	F_1 with F_2/F_3 or F_2/F_3 with F_4/F_5 :	Nail Patterns F_1
Angle Bracket 105 with rib:	F_1 with F_2/F_3 or F_2/F_3 with F_4/F_5 :	Nail Patterns F_1
Angle Bracket 105 without rib:	F_1 with F_2/F_3 :	Nail Patterns F_2/F_3
Angle Bracket 105 without rib:	F_1 with F_4/F_5 :	Nail Patterns F_4/F_5

Double angle brackets per connection

The angle brackets must be placed at each side opposite each other, symmetric to the component axis.

Acting forces

- F_1 Lifting force acting along the central axis of the joint.
- F_2 and F_3 Lateral force acting in the joint between the component 2 and component 1 in the component 2 direction
- F_4 and F_5 Lateral force acting in the component 1 direction along the central axis of the joint. If the load is applied with an eccentricity e , a design for combined loading is required.

Single angle bracket per connection

Acting forces

- F_1 Lifting force acting in the central axis of the angle bracket. The component 2 shall be prevented from rotation. If the component 2 is prevented from rotation the load-carrying capacity will be half of a connection with double angle brackets.
- F_2 and F_3 Lateral force acting in the joint between the component 2 and the component 1 in the component 2 direction. The component 2 shall be prevented from rotation. If the component 2 is prevented from rotation the load-carrying capacity will be half of a connection with double angle brackets.
- F_4 and F_5 Lateral force acting in the component 1 direction in the height of the top edge of component 2. F_4 is the lateral force towards the angle bracket; F_5 is the lateral force away from the angle bracket. Only the characteristic load-carrying capacities for angle brackets with ribs are given.

Wane

Wane is not allowed, the timber has to be sharp-edged in the area of the angle brackets.

Timber splitting

For the lifting force F_1 it must be checked in accordance with Eurocode 5 or a similar national Timber Code that splitting will not occur.

Combined forces

If the forces F_1 and F_2/F_3 or F_4/F_5 act at the same time, the following inequality shall be fulfilled:

$$\left(\frac{F_{1,d}}{F_{Rd,1}}\right)^2 + \left(\frac{F_{2,d}}{F_{Rd,2}}\right)^2 + \left(\frac{F_{3,d}}{F_{Rd,3}}\right)^2 + \left(\frac{F_{4,d}}{F_{Rd,4}}\right)^2 + \left(\frac{F_{5,d}}{F_{Rd,5}}\right)^2 \leq 1$$

The forces F_2 and F_3 or F_4 and F_5 are forces with opposite direction. Therefore only one force F_2 or F_3 , respectively, and F_4 or F_5 , respectively, is able to act simultaneously with F_1 , while the other shall be set to zero.

If the load F_4/F_5 is applied with an eccentricity e , a design for combined loading **for connections with double angle brackets** is required. Here, an additional force ΔF_1 has to be added to the existing force F_1 .

$$\Delta F_{1,d} = F_{4,d} / F_{5,d} \cdot \frac{e}{B}$$

B is the width of component 2.

Characteristic load-carrying capacities 2 angle brackets per connection

Table B.1: Characteristic load-carrying capacities Load F_1 – 2 angle brackets / connection

Angle Bracket	Nail number n_v	Nail number n_h	Timber $R_{Rk,H}$	Steel $R_{Rk,S}$
70 without rib	1,2,3	12,13,14,20,21,22	3,05 kN	1,56 kN
90 without rib	1,3,5	10,11,12,13,15,16,17,18,20	8,07 kN	2,34 kN
105 without rib	1,2,6,7,8,9,10	18,19,20,21,25,26,30,31	8,09 kN	4,50 kN
70 with rib	1,3	8,9,10,11,12,14	3,16 kN	4,57 kN
90 with rib	1,3,6,7	12,13,14,15,18,19	6,46 kN	8,59 kN
105 with rib	1,2,6,7	14,15,16,17,20,21,24,25	11,8 kN	14,0 kN
Angle bracket 70 with and without rib are connected with nails $\phi 4,0 \times 40$				
Angle bracket 90 and 105 with and without rib are connected with nails $\phi 4,0 \times 60$				

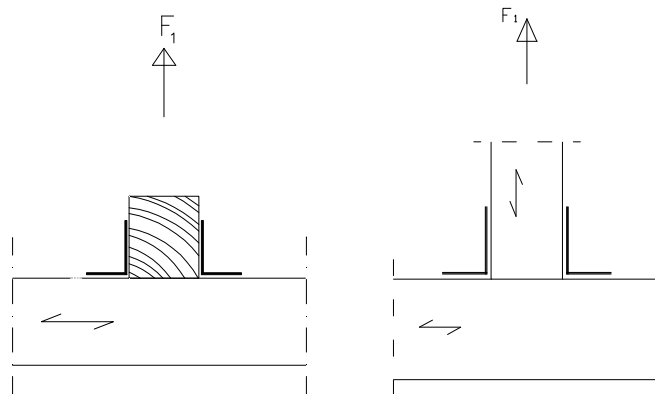

Table B.2: Characteristic load-carrying capacities Load $F_{2/3}$, 2 angle brackets / connection

Angle Bracket	Nail number n_v	Nail number n_h	Timber $R_{Rk,H}$
70 without rib	1,3,4,6,9,11	12,13,14,20,21,22	7,57 kN
90 without rib	1,3,4,5,6,7	10,11,12,13,15,16,17,18,20	9,55 kN
105 without rib	1,2,6,8,10,11,13, 14,15	18,19,20,21,27,28,29,33,34	12,8 kN
70 with rib	1,3,4,5	8,9,10,11,12,14	5,49 kN
90 with rib	1,3,6,7,8,9	12,13,16,17,20,22	8,39 kN
105 with rib	1,2,6,7,10,11	14,15,16,17,22,23,27,28	9,60 kN
Angle bracket 70 with and without rib are connected with nails $\phi 4,0 \times 40$			
Angle bracket 90 and 105 with and without rib are connected with nails $\phi 4,0 \times 60$			

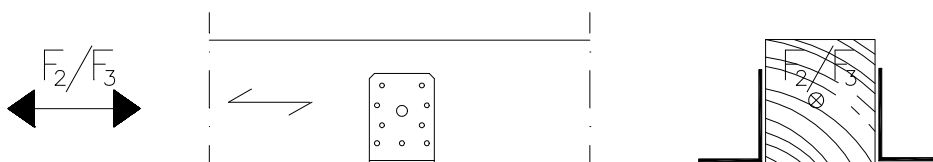
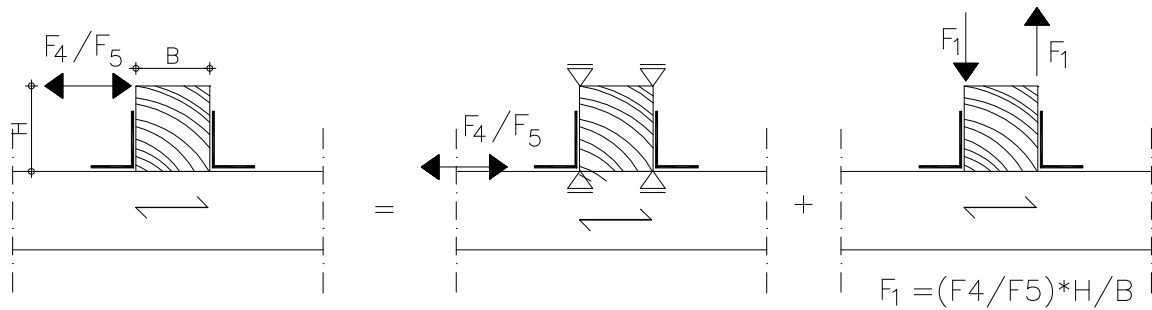

Table B.3: Characteristic load-carrying capacities Load $F_{4/5}$, 2 angle brackets / connection

Angle Bracket	Nail number n_v	Nail number n_h	Timber $R_{Rk,H}$	Steel $R_{Rk,S}$
70 without rib	1,2,3,4,6,7,8,	12,13,14,20,21,22	6,10 kN	3,63 kN
90 without rib	1,3,4,5,6,7	10,11,12,13,15,16,17,18,20	9,67 kN	3,99 kN
105 without rib	1,2,3,5,6,8,10,12,14,15	18,19,20,21,27,28,29,33,34	10,6 kN	7,98 kN
70 with rib	1,3,4,5	8,9,10,11,12,14	5,65 kN	4,12 kN
90 with rib	1,3,4,5,6,7,8,9	12,13,14,15,18,19	8,91 kN	6,55 kN
105 with rib	1,2,3,5,6,7,8,9,10,11	14,15,16,17,20,21,24,25	11,9 kN	11,8 kN

Angle bracket 70 with and without rib are connected with nails $\phi 4,0 \times 40$

Angle bracket 90 and 105 with and without rib are connected with nails $\phi 4,0 \times 60$



Characteristic load-carrying capacities with one angle bracket per connection**The force F_4 , respectively F_5 , is applied on the upper beam edge.****Table B.4:** Characteristic load-carrying capacities ($R_{Rk,H} / R_{Rk,S}$) Load F_4 (Force towards the angle bracket)

	H in m					
	0,08	0,10	0,12	0,14	0,16	0,20
70 with rib	0,82 kN/0,38 kN	0,66 kN/0,28 kN	-	0,47 kN/0,21 kN	-	-
90 with rib	-	-	1,11 kN/0,46 kN	0,95 kN/0,40 kN	0,84 kN/0,35 kN	-
105 with rib	-	-	2,42 kN/1,02 kN	-	1,82 kN/0,69 kN	1,37 kN/0,52 kN

Table B.5: Characteristic load-carrying capacities ($R_{Rk,H} / R_{Rk,S}$) Load F_5 (Force off the angle bracket)

70 with rib	H in m		
B in m	0,08	0,10	0,14
0,06	1,58 kN ; 0,93 kN	1,73 kN ; 1,12 kN	2,45 kN ; 1,06 kN
0,10	1,44 kN ; 1,30 kN	1,58 kN ; 1,19 kN	1,56 kN ; 1,26 kN
0,14	1,45 kN ; 1,29 kN	1,47 kN ; 1,28 kN	1,48 kN ; 1,26 kN

Table B.6: Characteristic load-carrying capacities ($R_{Rk,H} / R_{Rk,S}$) Load F_5 (Force off the angle bracket)

90 with rib	H in m		
B in m	0,12	0,14	0,16
0,08	3,85 kN ; 1,83 kN	4,24 kN ; 1,72 kN	4,89 kN ; 1,62 kN
0,10	3,49 kN ; 1,98 kN	3,65 kN ; 1,90 kN	3,88 kN ; 1,82 kN
0,14	3,23 kN ; 2,12 kN	3,30 kN ; 2,08 kN	3,37 kN ; 2,03 kN

Table B.7: Characteristic load-carrying capacities ($R_{Rk,H} / R_{Rk,S}$) Load F_5 (Force off the angle bracket)

105 with rib	H in m		
B in m	0,12	0,16	0,20
0,08	5,94 kN ; 3,14 kN	5,45 kN ; 2,67 kN	4,68 kN ; 2,30 kN
0,10	5,24 kN ; 3,55 kN	6,09 kN ; 3,13 kN	5,27 kN ; 2,80 kN
0,14	4,68 kN ; 3,99 kN	5,00 kN ; 3,72 kN	5,35 kN ; 3,47 kN

Annex C
Characteristic load-carrying capacities – brackets 1,5 mm thickness

Definitions of forces, their directions and eccentricity

Forces - Beam to beam connection

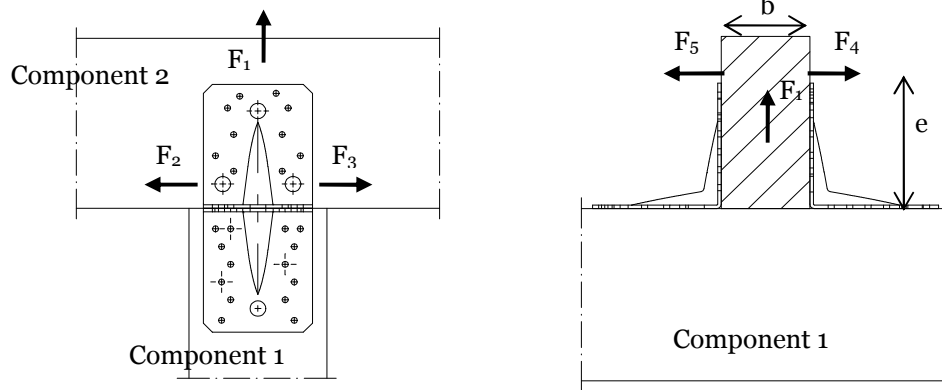

Fastener specification

A full nailing pattern is specified, where there are nails in all nail holes.

Double angle brackets per connection

The angle brackets must be placed at each side opposite each other, symmetric to the component axis.

Acting forces

- F_1 Lifting force acting along the central axis of the joint.
- F_{23} Lateral force acting in the joint between the component 2 and component 1 in the component 2 direction
- F_{45} Lateral force acting in the component 1 direction along the central axis of the joint. If the load is applied with an eccentricity e , a design for combined loading is required.

Single angle bracket per connection

Acting forces

- F_1 Lifting force acting in the central axis of the angle bracket. The component 2 shall be prevented from rotation. If the component 2 is prevented from rotation the load-carrying capacity will be half of a connection with double angle brackets.
- F_2 and F_3 Lateral force acting in the joint between the component 2 and the component 1 in the component 2 direction. The component 2 shall be prevented from rotation. If the component 2 is prevented from rotation the load-carrying capacity will be half of a connection with double angle brackets.

Wane

Wane is not allowed, the timber has to be sharp-edged in the area of the angle brackets.

Timber splitting

For the lifting force F_1 it must be checked in accordance with Eurocode 5 or a similar national Timber Code that splitting will not occur.

Combined forces

If the forces F_1 and F_2/F_3 or F_4/F_5 act at the same time, the following inequality shall be fulfilled:

$$\left(\frac{F_{1,Ed}}{F_{1,Rd}} \right)^2 + \left(\frac{F_{23,Ed}}{F_{23,Rd}} \right)^2 + \left(\frac{F_{45,Ed}}{F_{45,Rd}} \right)^2 \leq 1$$

If the load F_{45} is applied with an eccentricity e , a design for combined loading for connections with double angle brackets is required. Here, an additional force ΔF_1 has to be added to the existing force F_1 .

$$\Delta F_{1,d} = F_{4,d} / F_{5,d} \cdot \frac{e}{B} \quad \text{B is the width of component 2.}$$

Characteristic load-carrying capacities 2 angle brackets per connection

Table C.1: Characteristic load-carrying capacities Load F_1 – 2 angle brackets / connection

Angle Bracket	$F_{1,Rk}$	
70 with rib	10,8 kN	
90 with rib	9,8 kN	
105 with rib	18,4 kN	

Table C.2: Characteristic load-carrying capacities Load F_{23} , 2 angle brackets / connection

Angle Bracket	$F_{23,Rk}$	
70 with rib	12,7 kN	
90 with rib	12,2 kN	
105 with rib	17,0 kN	

Table C.3: Characteristic load-carrying capacities Load F_{45} , 2 angle brackets / connection

Angle Bracket	$F_{45,Rk}$	
70 with rib	11,0 kN	
90 with rib	13,5 kN	
105 with rib	16,4 kN	