



ZAVOD ZA  
GRADBENIŠTVO  
SLOVENIJE

SLOVENIAN  
NATIONAL BUILDING  
AND CIVIL ENGINEERING  
INSTITUTE



Member of  
[www.eota.eu](http://www.eota.eu)

**Dimičeva 12,  
1000 Ljubljana, Slovenija**

Tel.: +386 (0)1 280 44 72, +386 (0)1 280 45 37

Fax: +386 (0)1 280 44 84

e-mail: [info.ta@zag.si](mailto:info.ta@zag.si)

<http://www.zag.si>

## European Technical Assessment

**ETA-17/1009**  
of 16. 02. 2023

*English version prepared by ZAG*

### General Part

**Technical Assessment Body issuing the  
European Technical Assessment**

**ZAG Ljubljana**

**Trade name of the construction product**

**Sormat Concrete Screw Anchor S-CSA /  
EJOT Concrete Screw Anchor JC2**

**Product family to which the construction  
product belongs**

**33: Concrete screw of size 6 for multiple  
use for non-structural application in  
concrete and in pre-stressed hollow  
core slabs**

**Manufacturer**

**EJOT SORMAT OY  
Vähäkorventie 10  
21250 Masku  
Finland  
[www.ejot.fi](http://www.ejot.fi)**

**Manufacturing plant**

**EJOT production plants**

**This European Technical Assessment  
contains**

**15 pages including 12 annexes, which form  
an integral part of the document**

**This European Technical Assessment is  
issued in accordance with Regulation (EU)  
No 305/2011, on the basis of**

**EAD 330747-00-0601, edition May 2018**

**This European Technical Assessment  
replaces**

**ETA-17/1009 issued on 19. 08. 2021**

Translations of this European Technical Assessment in other languages shall fully correspond to the original issued document and should be identified as such.

Communication of this European Technical Assessment, including transmission by electronic means, shall be in full (excepted the confidential Annex(es) referred to above). However, partial reproduction may be made, with the written consent of the issuing Technical Assessment Body. Any partial reproduction has to be identified as such.

## **Specific parts**

### **1 Technical description of the product**

The Sormat Concrete Screw Anchor S-CSA / EJOT Concrete Screw Anchor JC2 is an anchor in size 6 made of galvanised or Multi Layer coated steel. The anchor is screwed into a predrilled cylindrical hole. The special thread of the anchor cuts an internal thread into the member while setting. The anchorage is characterised by mechanical interlock in the special thread.

For the installed anchor see Figure given in Annex A1.

### **2 Specification of the intended use(s) in accordance with the applicable European Assessment Document (hereinafter EAD)**

The performances given in Chapter 3 are only valid if the anchor is used in compliance with the specifications and conditions given in Annex B.

The provisions made in this European Technical Assessment are based on an assumed working life of the anchor of 50 years. The indications given on the working life cannot be interpreted as a guarantee given by the manufacturer, but are to be regarded only as a means for choosing the right products in relation to the expected economically reasonable working life of the works.

### **3 Performance of the product and references to the methods used for its assessment**

#### **3.1 Mechanical resistance and stability (BWR 1)**

For basic work requirement mechanical resistance and stability are included under the basic work requirement safety in use.

#### **3.2 Safety in case of fire (BWR 2)**

The basic work requirements for safety in case of fire are listed in Annex C4.

#### **3.3 Hygiene, health and environment (BWR 3)**

Regarding dangerous substances contained in this European Technical Assessment, there may be requirements applicable to the products falling within its scope (e.g. transported European legislation and national laws, regulations and administrative provisions). In order to meet provisions of the regulation (EU) No 305/2011, these requirements need also to be complied with, when they apply.

#### **3.4 Safety in use (BWR 4)**

The basic work requirements for safety in use are listed in Annexes C1, C2 and C3.

#### **3.5 Protection against noise (BWR 5)**

Not relevant.

#### **3.6 Energy economy and heat retention (BWR 6)**

Not relevant.

#### **3.7 Sustainable use of natural resources (BWR 7)**

No performance assessed.

#### **3.8 General aspects relating to fitness for use**

Durability and serviceability are only ensured if specifications of intended use according to Annex B1 are kept.

**4 Assessment and verification of constancy of performance (hereinafter AVCP) system applied, with reference to its legal base**

According to the decision 97/161/EC of the European Commission<sup>1</sup> the system of assessment and verification of constancy of performance (see Annex V to regulation (EU) No 305/2011) 2+ apply.

**5 Technical details necessary for the implementation of the AVCP system, as provided for on the applicable EAD**

**5.1 Tasks for the manufacturer**

Technical details necessary for the implementation of the AVCP system are laid down in Chapter 3 of EAD 330747-00-0601.

Issued in Ljubljana on 16. 02. 2023

Signed by:

Franc Capuder, M.Sc.

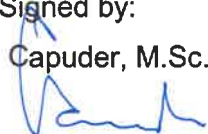

Head of Service of TAB

---

<sup>1</sup> Official Journal of the European Communities L 254 of 8.10.1996

**SORMAT Concrete Screw Anchors S-CSA / EJOT Concrete Screw Anchor JC2 after installation**

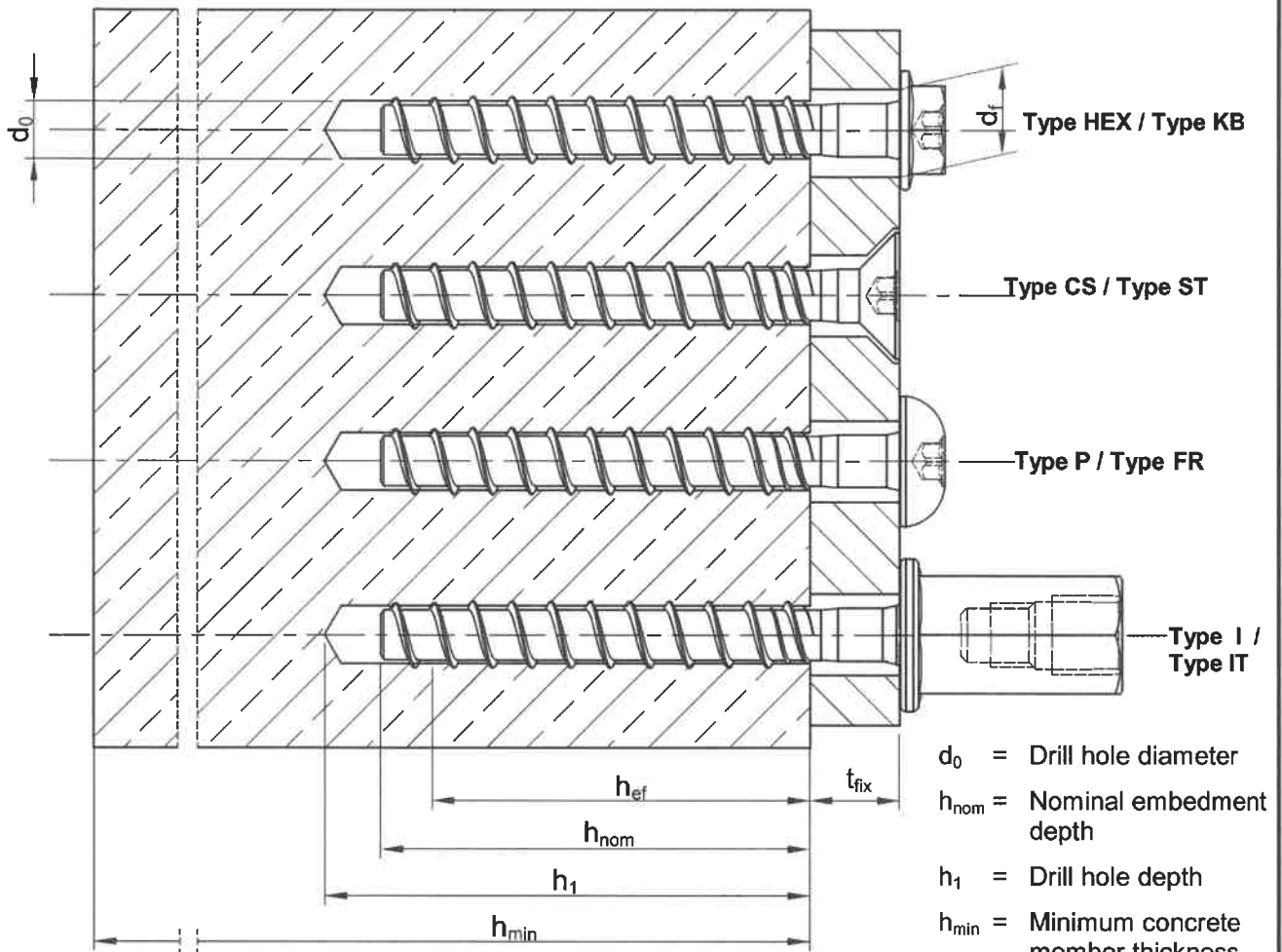

- $d_0$  = Drill hole diameter
- $h_{nom}$  = Nominal embedment depth
- $h_1$  = Drill hole depth
- $h_{min}$  = Minimum concrete member thickness
- $t_{fix}$  = Fixture thickness
- $d_f$  = Clearance hole diameter in fixture

**S-CSA / JC2 installed in pre-stressed hollow core slab**

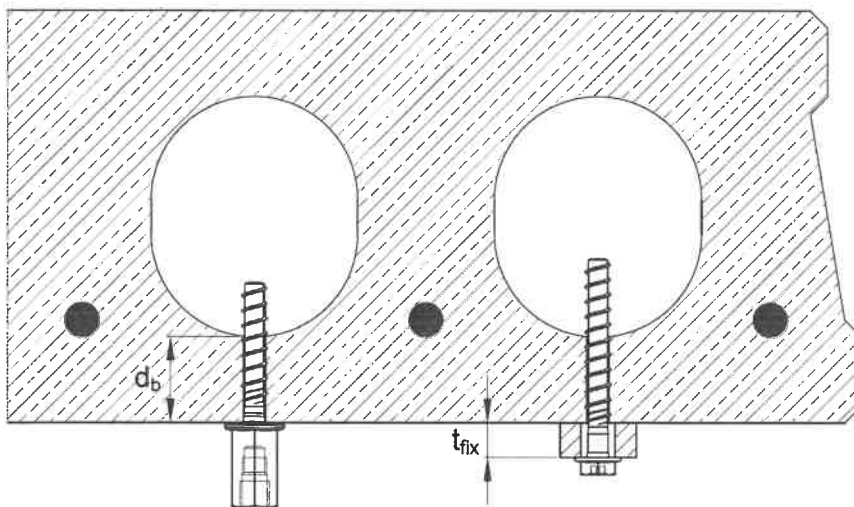

**Sormat Concrete Screw Anchor S-CSA /  
EJOT Concrete Screw Anchor JC2**

**Product description**  
Installation condition

**Annex A1**

**Table A1: Materials and Types**

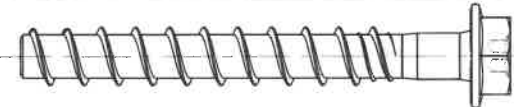
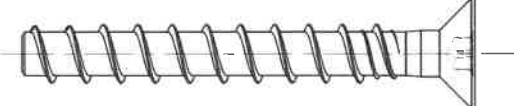
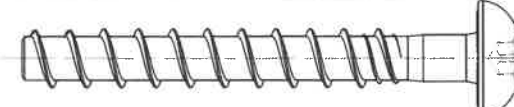
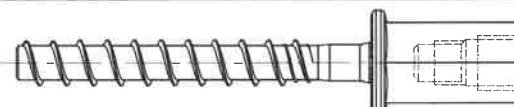
Material		$f_{yk}$ [N/mm <sup>2</sup> ]	$f_{uk}$ [N/mm <sup>2</sup> ]
Cold forged carbon steel, zinc electroplated according to EN ISO 4042 or with Multi Layer Coating (zinc alloy coated) $\geq 5\mu\text{m}$		640	800
Part	Designation	Description	Design
1	S-CSA HEX / JC2-KB	Hexagonal head version with combined washer and T-drive	
2	S-CSA CS / JC2-ST	Countersunk head version with T-drive	
3	S-CSA P / JC2-FR	Pan head version with T-drive	
4	S-CSA I / JC2-IT	Internal thread version with hexagonal drive	

**Table A2: Anchor dimensions and head marking**

Anchor size			S-CSA 6 / JC2-6
Nominal diameter	$d_{nom}$	[mm]	6
Thread outer diameter	$d_{th}$	[mm]	7,45
Core diameter	$d_k$	[mm]	5,55
Shaft diameter	$d_s$	[mm]	5,88
Stressed section	$A_s$	[mm <sup>2</sup> ]	24,19

**Marking:** Identifying mark: S or J  
Anchor identity: CSA or C2  
Nominal diameter:  $d_{nom}$   
Screw length: L  
**Example: S-CSA 6x100 or JC2-6x100**

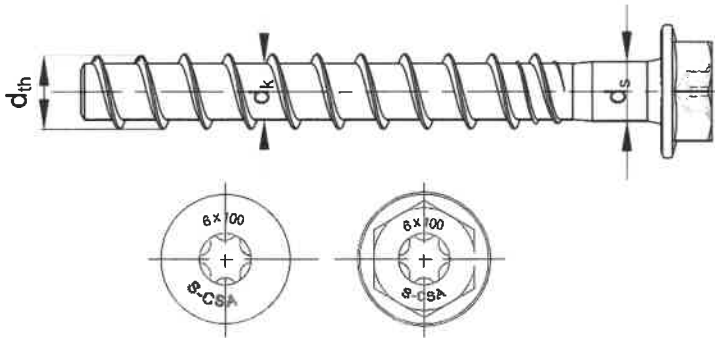

**Sormat Concrete Screw Anchor S-CSA /  
EJOT Concrete Screw Anchor JC2**

**Product description**  
Materials, types and dimensions

**Annex A2**

## Specifications of intended use

### Anchorage subjected to:

- Static, quasi static load.
- Use only for multiple use for non-structural applications according to EAD 330747-00-0601
- Fire exposure.

### Base materials:

- Cracked and non-cracked concrete.
- Reinforced and unreinforced normal weight concrete of strength class C20/25 at minimum and C50/60 at maximum according to EN 206:2013+A1:2016.
- Precast pre-stressed hollow core slabs.

### Use conditions (Environmental conditions):

- The anchor may be used in structures subject to dry internal conditions.

### Design:

- Anchorages are designed under the responsibility of an engineer experienced in anchorages and concrete work.
- Anchorages under static and quasi-static actions are designed in accordance with EOTA TR 055, Edition December 2016 or EN 1992-4:2018.
- For application with resistance under fire exposure the anchorages are designed in accordance with the method given in EOTA TR 020, Edition May 2004 or EN 1992-4:2018.
- Verifiable calculation notes and drawings are prepared taking into account of the load to be anchored. The position of the anchor is indicated on the design drawings (e.g. position of the anchor relative to reinforcement or to supports, etc.).

### Installation:

- Anchor installation carried out by appropriately qualified personnel and under the supervision of the person responsible for technical matters on the site.
- Use of the anchor only as supplied by the manufacturer without exchanging the components of an anchor.
- Anchor installation in accordance with the manufacturer's specifications and drawings using the appropriate tools.
- Checks before placing the anchor to ensure that the strength class of the concrete in which the anchor is to be placed is in the range given and is not lower than that of the concrete to which the characteristic loads apply for.
- Check of concrete being well compacted, e.g. without significant voids.
- Cleaning of the hole of drilling dust.
- Anchor installation ensuring the specified embedment depth.
- Keeping of the edge distance and spacing to the specified values without minus tolerances.
- Positioning of the drill holes without damaging the reinforcement.
- In case of aborted hole, drilling of new hole at a minimum distance of twice the depth of the aborted hole, or smaller distance provided the aborted drill hole is filled with high strength non-shrinkage mortar. No shear or oblique tension loads are allowed in the direction of a not filled aborted hole.
- Application of the torque moment given in Annex B2 using a calibrated torque wrench.

**Sormat Concrete Screw Anchor S-CSA /  
EJOT Concrete Screw Anchor JC2**

**Intended use  
Specifications**

**Annex B1**

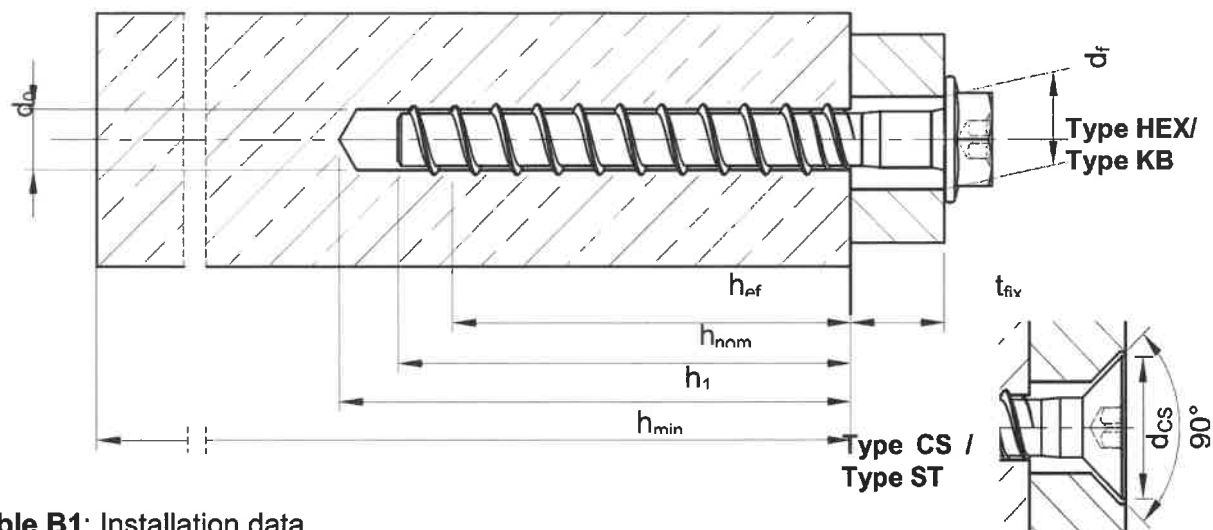

**Table B1:** Installation data

SORMAT Concrete Screw Anchor S-CSA / EJOT Concrete Screw Anchor JC2			Anchor size	
			S-CSA 6-1 / JC2-6-1	S-CSA 6-2 / JC2-6-2
Nominal embedment depth	$h_{nom}$	[mm]	35	40
Drill hole diameter	$d_0$	[mm]	6	6
Cutting diameter at the upper tolerance limit (maximum diameter bit)	$d_{cut,max} \leq$	[mm]	6,40	6,40
Depth of drilled hole to deepest point	$h_1 \geq$	[mm]	45	50
Effective anchorage depth	$h_{ef}$	[mm]	27,6	31,9
Diameter of clearance hole in the fixture	$d_f \leq$	[mm]	7,7 – 9,0	7,7 – 9,0
Countersunk head diameter (Type CS / ST)	$d_{CS}$	[mm]	14	14
T-drive	T-	[-]	30	30
Width across flats	SW	[mm]	11 or 13	11 or 13
Required torque	$T_{inst}$	[Nm]	14	14
Max installation torque for impact screw driver	$T_{SD}$	[Nm]	90	90

**Table B2:** Minimum thickness of concrete member, spacing and edge distance

SORMAT Concrete Screw Anchor S-CSA / EJOT Concrete Screw Anchor JC2			Anchor size	
			S-CSA 6-1 / JC2-6-1	S-CSA 6-2 / JC2-6-2
Minimum thickness of concrete member	$h_{min}$	[mm]	80	100
Minimum spacing	$s_{min}$	[mm]	35	35
Minimum edge distance	$c_{min}$	[mm]	30	35

**SORMAT Concrete Screw Anchor S-CSA /  
EJOT Concrete Screw Anchor JC2**

**Intended use**  
Installation data

**Annex B2**





# Installation instructions

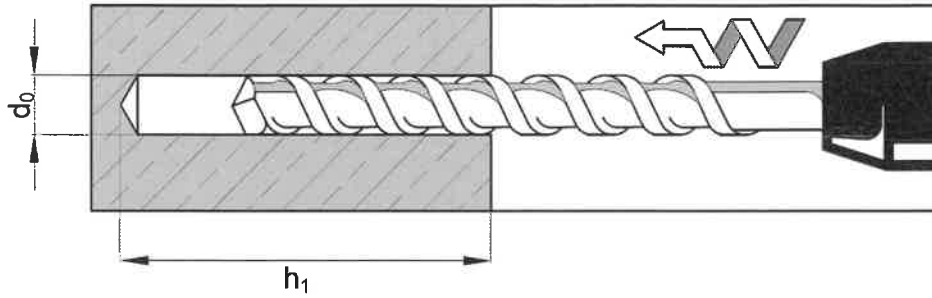

Make a cylindrical hole

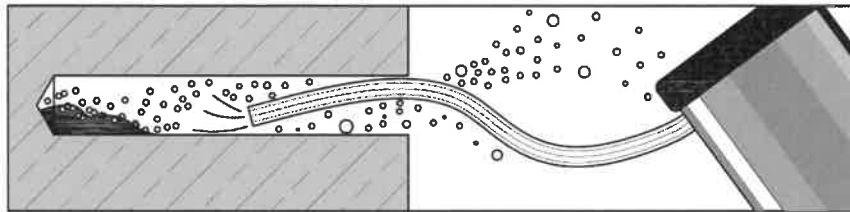

Clean the hole

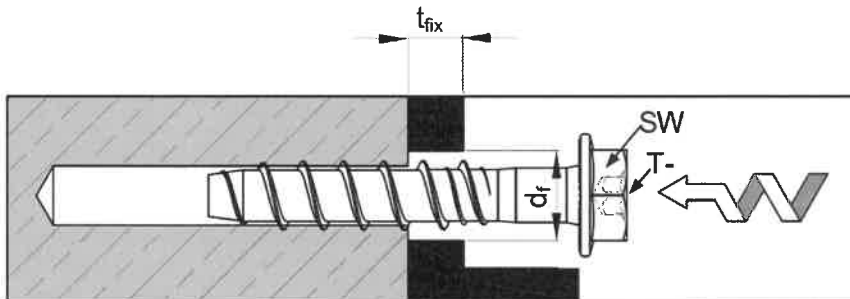

Install the screw anchor by impact screwdriver or torque wrench

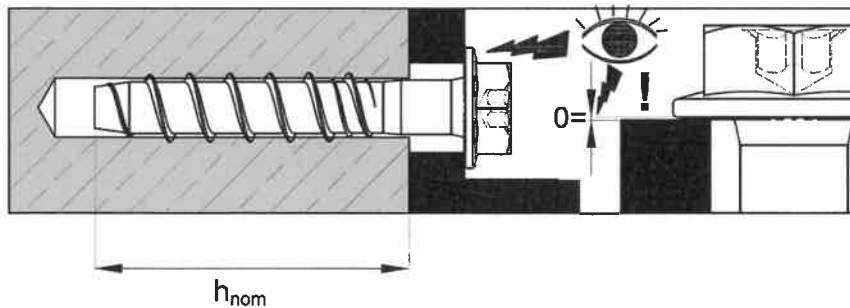

Ensure that the screw anchor head fully rests without any gap on the fixture and is not damaged

**Sormat Concrete Screw Anchor S-CSA /  
EJOT Concrete Screw Anchor JC2**

**Intended use**

Installation instructions in concrete

**Annex B4**

## Installation instructions in pre-stressed hollow core slabs

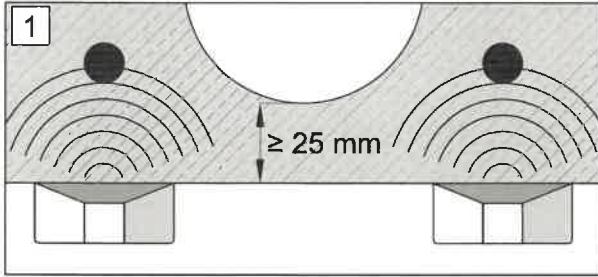

1 Locate rebars by means of suitable detector

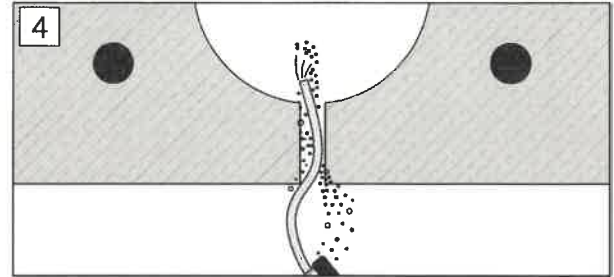

4 Clean the hole

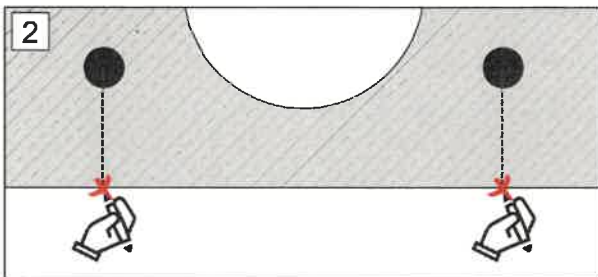

2 Mark rebar location

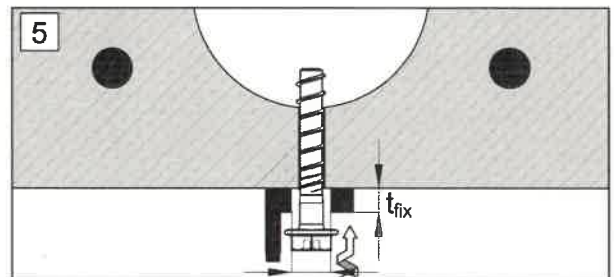

5 Install the screw anchor by impact screwdriver or torque wrench

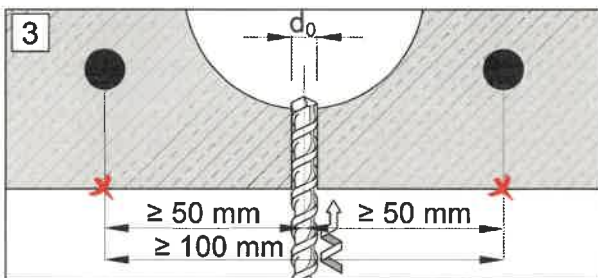

3 Make a cylindrical hole

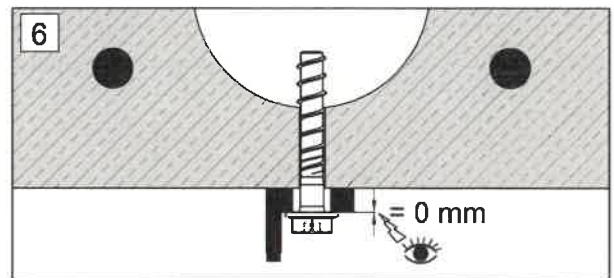

6 Ensure that the screw anchor head fully rests without any gap on the fixture and is not damaged

**Sormat Concrete Screw Anchor S-CSA /  
EJOT Concrete Screw Anchor JC2**

**Intended use**

Installation instructions in pre-stressed hollow core slabs

**Annex B5**

**Table C1:** Characteristic resistances under tension loads in case of static and quasi-static loading for design according to EOTA TR 055 or EN 1992-4:2018

SORMAT Concrete Screw Anchor S-CSA / EJOT Concrete Screw Anchor JC2			Anchor size	
			S-CSA 6-1 / JC2-6-1	S-CSA 6-2 / JC2-6-2
<b>Steel failure</b>				
Characteristic resistance	$N_{Rk,s}$	[kN]	19,4	
Partial safety factor	$\gamma_{Ms}$ <sup>1)</sup>	[-]	1,5	
<b>Pull-out failure</b>				
Characteristic resistance in <b>cracked</b> and <b>non-cracked</b> concrete C20/25	$N_{Rk,p}$	[kN]	3	3,5
Increasing factor for $N_{Rk,p}$	$\psi_C$	C25/30	1,04	1,07
		C30/37	1,07	1,14
		C35/45	1,10	1,20
		C40/50	1,13	1,26
		C45/55	1,15	1,31
		C50/60	1,18	1,36
Partial safety factor	$\gamma_2$	[-]	1,0	1,0
	$\gamma_{Mp}$ <sup>1)</sup>	[-]	1,5 <sup>2)</sup>	1,5 <sup>2)</sup>
<b>Concrete cone and splitting failure</b>				
Effective anchorage depth	$h_{ef}$	[mm]	27,6	31,9
Factor for cracked concrete	$k_{cr}$	[-]	7,7	
Factor for non-cracked concrete	$k_{ucr}$	[-]	11,0	
Spacing	$s_{cr,N}$	[mm]	83	96
Edge distance	$c_{cr,N}$	[mm]	41,5	48
Spacing (splitting)	$s_{cr,sp}$	[mm]	110	96
Edge distance (splitting)	$c_{cr,sp}$	[mm]	55	48
Partial safety factor	$\gamma_{Msp}$ <sup>1)</sup>	[-]	1,5 <sup>2)</sup>	1,5 <sup>2)</sup>

<sup>1)</sup> In absence of other national regulations

<sup>2)</sup> The installation safety factor of  $\gamma_2 = 1,0$  is included

<b>Sormat Concrete Screw Anchor S-CSA / EJOT Concrete Screw Anchor JC2</b>	<b>Annex C1</b>
<b>Performance</b> Characteristic resistance under tension loads	

**Table C2:** Characteristic resistances under shear loads in case of static and quasi-static loading for design according to EOTA TR 055 or EN 1992-4:2018

SORMAT Concrete Screw Anchor S-CSA / EJOT Concrete Screw Anchor JC2			Anchor size	
			S-CSA 6-1 / JC2-6-1	S-CSA 6-2 / JC2-6-2
<b>Steel failure without lever arm</b>				
Characteristic resistance	$V_{Rk,s}$	[kN]	9,4	9,4
Partial safety factor	$\gamma_{Ms}$ <sup>1)</sup>	[-]	1,25	
Factor for considering ductility	$K_7$	[-]	0,8	
<b>Steel failure with lever arm</b>				
Characteristic resistance	$M_{Rk,s}^0$	[Nm]	16	
Partial safety factor	$\gamma_{Ms}$ <sup>1)</sup>	[-]	1,25	
<b>Concrete pryout failure</b>				
k-factor	$k_B$	[-]	2,6	
Partial safety factor	$\gamma_{Mc}$ <sup>1)</sup>	[-]	1,5	1,5
<b>Concrete edge failure</b>				
Effective length of anchor under shear load	$l_f$	[mm]	27,6	31,9
Outside diameter of anchor	$d_{nom}$	[mm]	6	
<b>Cracked concrete</b> without any edge reinforcement	$\Psi_{ucr,V}$	[-]	1,0	
<b>Cracked concrete</b> with straight edge reinforcement > Ø12 mm			1,2	
<b>Cracked concrete</b> with edge reinforcement and closely spaced stirrups ( $a \leq 100\text{mm}$ ) or <b>non-cracked concrete</b>			1,4	
Partial safety factor			$\gamma_{Mc}$ <sup>1)</sup>	[-]

<sup>1)</sup> In absence of other national regulations

<b>Sormat Concrete Screw Anchor S-CSA / EJOT Concrete Screw Anchor JC2</b>	<b>Annex C2</b>
<b>Performance</b> Characteristic resistance under shear loads	

**Table C3:** Characteristic resistances for precast pre-stressed hollow core slabs C30/37 to C50/60

SORMAT Concrete Screw Anchor S-CSA / EJOT Concrete Screw Anchor JC2			Anchor size		
			S-CSA 6-1/S-CSA 6-2 JC2-6-1/JC2-6-2		
Installation safety factor	$\gamma_2 = \gamma_{inst}$	[-]	1,0		
Flange thickness	$d_b$	[mm]	$\geq 25$	$\geq 30$	$\geq 40$
Characteristic resistance for all directions	$F_{Rk}$	[kN]	2,5	3,5	5,0
Characteristic bending moment	$M^0_{Rk,s}$	[Nm]	16		
Edge distance	$c_{cr} = c_{min}$	[mm]	100		
Spacing	$s_{cr} = s_{min}$	[mm]	100		

Sormat Concrete Screw Anchor S-CSA /  
EJOT Concrete Screw Anchor JC2

**Performance**

Characteristic resistances for precast pre-stressed hollow core  
slabs

**Annex C3**

**Table C4:** Characteristic resistances under tension loads in case of fire exposure for design according to EOTA TR 020 or EN 1992-4:2018

Sormat Concrete Screw Anchor S-CSA / EJOT Concrete Screw Anchor JC2			Anchor size	
			S-CSA 6-1 / JC2-6-1	S-CSA 6-2 / JC2-6-2
<b>Steel failure</b>				
Characteristic resistance $N_{Rk,s,fi}$	R30	[kN]	0,24	
	R60	[kN]	0,22	
	R90	[kN]	0,17	
	R120	[kN]	0,12	
<b>Pull-out failure</b>				
Characteristic resistance $N_{Rk,p,fi}$	R30	[kN]	0,75	0,88
	R60	[kN]	0,75	0,88
	R90	[kN]	0,75	0,88
	R120	[kN]	0,60	0,70
<b>Concrete cone and splitting failure<sup>1)</sup></b>				
Characteristic resistance $N^0_{Rk,c,fi}$	R30	[Nm]	0,69	0,99
	R60	[Nm]	0,69	0,99
	R90	[Nm]	0,69	0,99
	R120	[Nm]	0,55	0,79
Spacing	$s_{cr,N,fi}$	[mm]	4 x $h_{ef}$	
	$s_{min}$	[mm]	100	
Edge distance	$c_{cr,N,fi}$	[mm]	2 x $h_{ef}$	
	$c_{cr,N,fi}$	[mm]	Fire attack from one side: $c_{min} = 2 \times h_{ef}$ Fire attack from more than one side: $c_{min} \geq 300 \text{ mm and } \geq 2 \times h_{ef}$	

<sup>1)</sup> As a rule, splitting failure can be neglected when cracked concrete and reinforcement is assumed

Design under fire exposure is performed according to the design method given in EOTA TR 020 or EN 1992-4:2018.

Under fire exposure usually cracked concrete is assumed. The design equations are given in EOTA TR 020 § 2.2.1 and EN 1992-4:2018 § D.4.2.

In the absence of other national regulations the partial safety factor for resistance under fire exposure  $\gamma_{M,fi} = 1,0$  is recommended.

**Sormat Concrete Screw Anchor S-CSA /  
EJOT Concrete Screw Anchor JC2**

**Performance**

Characteristic resistances under fire exposure

**Annex C4**

**Table C5:** Characteristic resistances under shear loads in case of fire exposure for design according to EOTA TR 020 or EN 1992-4:2018

Sormat Concrete Screw Anchor S-CSA / EJOT Concrete Screw Anchor JC2			Anchor size	
			S-CSA 6-1 / JC2-6-1	S-CSA 6-2 / JC2-6-2
<b>Steel failure without lever arm</b>				
Characteristic resistance $V_{Rk,s,fi}$	R30	[kN]	0,24	
	R60	[kN]	0,22	
	R90	[kN]	0,17	
	R120	[kN]	0,12	
<b>Steel failure with lever arm</b>				
Characteristic resistance $M^0_{Rk,s,fi}$	R30	[kN]	0,20	
	R60	[kN]	0,18	
	R90	[kN]	0,14	
	R120	[kN]	0,10	
<b>Concrete pryout failure</b>				
k factor	$k_8$	[-]	2,6	
Characteristic resistance $V_{Rk,cp,fi}$	R30	[Nm]	0,69	0,99
	R60	[Nm]	0,69	0,99
	R90	[Nm]	0,69	0,99
	R120	[Nm]	0,55	0,79
<b>Concrete edge failure</b>				
The initial value $V^0_{Rk,c,fi}$ of the characteristic resistance in concrete C20/25 to C50/60 under fire exposure may be determined by:				
$V^0_{Rk,c,fi} = 0,25 \times V^0_{Rk,c} \quad (\leq R90) \qquad V^0_{Rk,c,fi} = 0,20 \times V^0_{Rk,c} \quad (R120)$				
with $V^0_{Rk,c}$ initial value of the characteristic resistance in cracked concrete C20/25 under normal temperature.				

Design under fire exposure is performed according to the design method given in EOTA TR 020 or EN 1992-4:2018.

Under fire exposure usually cracked concrete is assumed. The design equations are given in EOTA TR 020 § 2.2.2 and EN 1992-4:2018 § D.4.3..

EOTA TR 020 and EN 1992-4:2018 cover design for fire exposure from one side. For fire attack from more than one side the edge distance must be increased to  $c_{min} \geq 300$  mm and  $\geq 2 \times h_{ef}$ .

In the absence of other national regulations the partial safety factor for resistance under fire exposure  $\gamma_{M,fi} = 1,0$  is recommended.

<b>Sormat Concrete Screw Anchor S-CSA / EJOT Concrete Screw Anchor JC2</b>	<b>Annex C5</b>
<b>Performance</b> Characteristic resistances under fire exposure	